





SHOCK ABSORBERS





SPRINT Shocks SPRINT Shocks

MODEL	Note	YEAR	SPRINT Shocks		SPRINT Shocks	
			Fr 	£ ea EX VAT	Rr 	£ ea EX VAT
AC						
AC 3000ME	AS	72-81				
ACE Aceca		53-62				
Cobra MK II		62-63				
ALFA ROMEO						
1900; 2000; 2600 (all models excl. Berlina)		58-68				
2000; 2600 Berlina		58-68				
147 Coupe, GTA		01/01-	SUAL001V	39.99	SUAL001H	59.99
155 1.7, 1.8+ 2.0TS, 2.0TD, 2.5V6, 2.5TD (excl. EDC)		92-96				
156		09/97-	SUAL001V	39.99	SUAL001H	59.99
6 2.0 / 2.5 Turbo Diesel		79-86				
75 (all models)		5/85-91				
90 (all models)		9/84-87				
Alfetta GT / GTV		72-86				
Giulia 1300; 1600 Berlina GT Spider		62-80				
Giulia 1300; 1600 Junior		62-80				
Giulia 1750; 2000 Berlina GT Spider		62-80				
Giulia 1600 Spider, Sprint, SS		55-64				
Giulietta 1300 Berlina 1300		55-64				
Giulietta 1750 GT Spider		68-72				
Giulietta 2000 GT; GTV		71-76				
Giulietta Saloon (all models)		78-87				
GT		11/03-	SUAL001V	39.99	SUAL001H	59.99
GTV 6 Coupe		80-11/84				
GTV 6 Coupe - 2.0 / 2.5		85-89				
Montreal		73-77				
Sud/Sprint (excl. 1.7 with Alfa 33 suspension)		72-87				
ALVIS						
3 Litre - type TF		63-67				
AUDI						
80 / 90						
80 / 90 1.3; 1.6; 1.8 & Coupe - type 81	(3)	8/78-9/88	SUAU001V	49.99	SUAU001H	39.99
	AS					
80 / 90 Cabriolet - type 89		6/91-	SUAU001V	49.99	SUAU0011H	49.99
80 / 90 Quattro excl. 20v - type 89Q	(2)	08/84-91	SUAU001V	49.99	SUAU006H	49.99
80 2.6; 2.8; V6 & Coupe - type B4	(3)	9/91-95	SUAU001V	49.99	SUAU002H	39.99



SHOCK ABSORBERS

MODEL	Note	YEAR	SPRINT Shocks		SPRINT Shocks	
			Fr 	£ ea EX VAT	Rr 	£ ea EX VAT
80 Avant 1.6; 1.9TDi; 2.0; 2.3; 2.6; 2.8 - type B4	(3)	1992-	SUAU001V	49.99	SUAU002H	39.99
80 1.6; 1.9TDi; 2.0; 2.3 & Coupe - type B4	(3)	1992-	SUAU001V	49.99	SUAU002H	39.99
80 Quattro - type B4Q		10/91-95	SUAU001V	49.99		
Coupe						
Coupe (excl. Quattro)		8/80-9/88	SUAU001V	49.99	SUAU001H	39.99
Coupe 2.0E / 2.3E / 2.3E-20v		89-	SUAU001V	49.99		
Coupe Quattro (excl. 20v)		83-89	SUAU001V	49.99		
Coupe Quattro (incl. 20v & S2)		89-96	SUAU001V	49.99		
Cabriolet 2.3E		92-	SUAU001V	49.99		
100 / 200						
100 / 200 Saloon (excl. Quattro & Turbo) - type 44	(2)	83-4/91	SUAU004V	49.99	SUAU004H	39.99
	AS					
100 / 200 Quattro incl. Avant (excl. 20v) - type 44Q		84-90	SUAU004V	49.99		
100 / 200 Quattro 20v incl. Avant - type 44Q		89-90	SUAU004V	49.99		
100 / 200 Saloon; Quattro; Avant - type C4	(2)	12/90-94	SUAU004V	49.99	SUAU004H	39.99
	AS					
100 Avant Quattro - type C4		91-5/94				
200		80-9/83	SUAU004V	49.99		
V8 - type D11		6/90-5/94	SUAU004V	49.99		
A3						
A3 1.6	(2,17)	9/96-04/03	SUVW004V	49.99	SUVW0041H	39.99
					SUVW004H	49.99
A3 1.8/1.8T/Tdi (Manual)	(2,17)	9/96-04/03	SUVW004V	49.99	SUVW0041H	39.99
					SUVW004H	49.99
A3 TDi (Auto)	(2,17)	9/96-04/03	SUVW004V	49.99	SUVW0041H	39.99
A3 1.6/1.8	(2,17)	9/96-04/03			SUVW004H	49.99
A3 1.8T/Tdi	(2,17)	9/96-04/03			SUVW004H	49.99
A3 (Front Strut Diameter 50mm (1.96"))		05/03-	SUVW008V	59.99	SUVW008H	49.99
A3 (Front Strut Diameter 55mm (2.15"))		05/03-	SUVW0081V	59.99	SUVW008H	49.99





SHOCK ABSORBERS



SPRINT Shocks



SPRINT Shocks

MODEL	Note	YEAR	SPRINT Shocks		SPRINT Shocks	
			Fr 	£ ea EX VAT	Rr 	£ ea EX VAT
A4						
A4 - type B5 (excl. Quattro) (incl. Avant)		95-01/99	SUAU003V	49.99	SUAU003H	49.99
A4 4/6cyl (incl. Quattro) (incl. Avant, Cabrio)		11/00-	SUAU007V	49.99	SUAU007H	49.99
A6						
A6 - type C4	(2)	94-5/97	SUAU004V	49.99	SUAU004H	39.99
A6 5 / 6cyl & 2.5TDi Avant - type C4	(2)	94-5/97				
A6 - type 4B (excl. Quattro & Avant)	(2)	4/97-12/03	SUAU003V	49.99	SUAU005H	49.99
A6 - type 4F		04/04-	SUAU008V	49.99	SUAU008H	49.99
UR Quattro		81-89				
TT						
TT (2WD)		99-	SUVW004VQ	49.99	SUVW0041H	39.99
TT (4WD)		99-	SUVW004VQ	49.99	SUVW004HQ	49.99
BMW						
BMW 1 Series E87						
All Models		09/04-	SUBM008VL,R	59.99	SUBM008H	49.99
BMW E6; E10						
1502; 1600-2; 1602; 1802; 2002; Ti; Tii; 2002 Turbo; Touring; Cabriolet		66-77				
BMW 3 SERIES E21						
315; 316; 318; 318i; 320/40; 320/6; 320i (45mm strut insert) incl. M-Technik		75-82				
323i & M-Technik (51mm strut insert)		78-82				
BMW 3 SERIES E30						
Saloon; Touring 4 Cylinder (excl. 4x4) - (45mm strut)		8/82-93	SUBM001V	49.99	SUBM002H	39.99
Saloon; Touring; 6 Cylinder (excl. 4x4) - (51mm strut)		8/82-93	SUBM002V	49.99	SUBM002H	39.99
Cabrio 4&6 Cylinder - (51mm strut)		86-93	SUBM002V	49.99	SUBM002H	39.99
325ix (4x4)		86-7/90			SUBM002H	39.99
325i SE Sport		8/82-7/90				
M3		87-93	SUBM002V	49.99	SUBM002H	39.99



SHOCK ABSORBERS



MODEL	Note	YEAR	SPRINT Shocks		SPRINT Shocks	
			Fr 	£ ea EX VAT	Rr 	£ ea EX VAT
BMW 3 SERIES E36						
Compact	(4)	10/94-98	SUBM003VL,R	69.99	SUBM002H	39.99
Saloon; Coupe 316i; 318; 318i; 318TDS	(4)	12/90-5/92			SUBM003H	39.99
Saloon; Coupe 316i; 318; 318i; 318TDS	(4)	6/92-98	SUBM003VL,R	69.99	SUBM003H	39.99
Cabriolet 318i	(4)	93-01/95	SUBM003VL,R	69.99	SUBM003H	39.99
Cabriolet 318i	(4)	02/95-98	SUBM003VL,R	69.99	SUBM003H	39.99
Saloon 320i; 323i; 325i; 325TD	(4)	12/90-5/92			SUBM003H	39.99
Coupe 320i; 323i; 325i; 325TD; 325TDS	(4)	6/92-12/95			SUBM003H	39.99
Coupe 320i; 323i; 325i; 328i; 325TD; 325TDS	(4)	12/95-98	SUBM003VL,R	69.99	SUBM003H	39.99
Cabriolet 320i; 323i; 325i & 328i	(4)	93-98			SUBM003H	39.99
Touring 316i; 318i; 318TDS; 320i; 325TD; 328i	(4)	5/95-99	SUBM003VL,R	69.99	SUBM003H	39.99
BMW 3 SERIES E46						
Compact		06/01-	SUBM005VL,R	59.99	SUBM003H	39.99
Saloon; Coupe; Touring; Cabrio		02/98-	SUBM005VL,R	59.99	SUBM003H	39.99
BMW 3 SERIES E90; E91						
Saloon; Coupe; Touring		01/05-	SUBM008VL,R	59.99	SUBM008H	49.99
BMW 5 SERIES E28						
518i; 520i; 525e/i; 528i; M535i, 524TD		7/81-10/87				
BMW 5 SERIES E34						
518i; 520i Excl. Sport Suspension	(6,8)	88-95			SUBM004H	49.99
525i; 530i; 535i; 524TD; 518i Sport Suspension;	(8)	88-7/90	SUBM0042V	59.99	SUBM004H	49.99
520i; 524TD; 525TD; 525TDS; 530i Sport Suspension (excl. Self Levelling Susp.)		88-7/90				
535i; 540i (excl. Self Levelling Susp.)		8/90-95	SUBM004V	59.99	SUBM004H	49.99
518i Sport-Suspension; 525i; 530i; 535i; 524TD;		8/90-95				
520i Sport-Suspension; 540i; 525TDS; 525TD; 530i 535i (excl. Self Levelling Susp.)		8/90-09/92				
525iX		5/91-			SUBM004H	49.99
518i; 520i Touring	(6,8)	90-97				
520i Touring Sport Suspension; 525i; 525TD; 540i		90-97	SUBM004V	59.99		
BMW 5 SERIES E39						
Saloon	(25)	11/95-	SUBM007V	69.99	SUBM007H	59.99
Saloon (ONLY M-TECHNIK)	(25)		SUBM0071V	69.99	SUBM007H	59.99
Touring	(25)	11/95-	SUBM007V	69.99	SUBM0071H	59.99
Touring (ONLY M-TECHNIK)	(25)		SUBM0071V	69.99	SUBM0071H	59.99
BMW 5 SERIES E60; E61						
Saloon (excl. M5)		7/03-	SUBM009V	69.99	SUBM009H	59.99
Touring (excl. M5)		6/04-				





SHOCK ABSORBERS



SPRINT Shocks

SPRINT Shocks

MODEL	Note	YEAR	SPRINT Shocks		SPRINT Shocks	
			Fr 	£ ea EX VAT	Rr 	£ ea EX VAT
BMW E3						
2500; 2.8L; 2800 CS Coupe; 3.0S; 3.0L; 3.0Si; 3.0 CS Coupe; 3.3L		69-76				
BMW 6 SERIES E24						
628CSi; 635i; 635CSi (excl. M635, M6) (excl. Self Levelling Susp.)		6/82-90				
BMW 7 Series E32						
730i; 735i; 750i (excl. Self Levelling Susp.)	(7,8)	3/88-7/90	SUBM0042V	59.99		
730i; 735i, 740i; 750i (excl. Self Levelling Susp.)	(7,8)	8/90-7/94	SUBM004V	59.99		
BMW Z Series						
Z1 Roadster (44mm id Rear Springs only)		2/91-94	SUBM002V	49.99	SUBM002H	39.99
Z3 (excl. M-Roadster & Coupe) 4&6 cyl		95-	SUBM003VL,R	69.99	SUBM002H	39.99
BOND						
Equipe (all models)	AS	67-70				
BRITISH LEYLAND						
See Rover						
CATERHAM						
Series 7 - De Dion axle Standard Track	AS	96-				
Series 7 - De Dion axle Wide Track	AS	96-				
Series 7 - De Dion axle	AS	91-96				
Series 7 - De Dion axle: stem / loop fitting	AS	89-				
Series 7 - Live axle	AS	72-				
Caterham 21	AS	96-				
CHEVROLET						
Corvette Series II - all models		63-82				
Corvette Series III - all models		83-87				
CHRYSLER (SIMCA)						
See Talbot (France)						
CHRYSLER (UK)						
See Talbot (UK)						



SHOCK ABSORBERS



SPRINT Shocks SPRINT Shocks



MODEL	Note	YEAR	FRONT		REAR	
			Fr	£ ea EX VAT	Rr	£ ea EX VAT
CITROEN						
AX		86-				
C2 1.6 16V		03-				
C4 Saloon; Coupe		11/04-	SUPE04VL,R	59.99	SUPE004H	49.99
Saxo		96-				
VISA (all models excl. GTi)		78-86				
VISA, GTi, 205 GTi		84-86	SUPE001VL,R	49.99		
Xsara TypeN6 (all models)		97-	SUPE003V	49.99	SUPE003H	39.99
ZX		6/92-	SUPE003V	49.99	SUPE003H	39.99
DAEWOO						
Espero, type KLE-J, up to 77KW, ABE-no. H019		95-97	SUOP004V	49.99	SUOP002H	39.99
Nexia, type KLE-TN, up to 66KW, ABE-no. H 18		95-97	SUOP004V	49.99	SUOP002H	39.99
DAIHATSU						
Charade Hatchback 3cyl., & GTi		87-93				
Charmant 1300 / 1500LD Saloon types A35 & A55		82-88				
Charmant 1300; 1450; 1600; 1600 EL Saloon. type A45&A55		82-88				
Fourtrak, Rocky, Taft, GT & Wildcat 4x4 types G70 & F75		84-89				
Taft		74-83				
DAIMLER						
2.5 Litre V8 250		62-69				
Double Six		72-79				
SP250 Dart		59-64				
Sovereign 2.8; 4.2 Litre		70-86				
Sovereign 2.8; 4.2 Litre		61-69				



SHOCK ABSORBERS



SPRINT Shocks SPRINT Shocks

MODEL	Note	YEAR	SPRINT Shocks		SPRINT Shocks	
			Fr 	£ ea EX VAT	Rr 	£ ea EX VAT
FIAT						
124 Coupe (up to Chassis no. 066058)		67-8/68				
124 Coupe (from Chassis no. 066059)		9/69-76				
124 Estate		8/66-75				
124 Saloon (up to Chassis no. 466320)		66-8/68				
124 Saloon (from Chassis no. 466321)		9/69-76				
124 Sport; Special; Special T		68-75				
124 Spyder (up to Chassis no. 1759186)		to 8/68				
124 Spyder (from Chassis no. 1759187)		9/69-76				
X 1/9 1.3; 1.5		73-78				
1500 Comfort		64-68				
2300 S Coupe		63-68				
500; 500D; 500 Giardiniera		57-77				
600; 600D; 600E		55-71				
850 (all models excl. Van)		60-68				
Mirafiori Super Estate 131		3/78-84				
Mirafiori Super Saloon 131		3/78-84				
126 (all models)		72-91				
Bravo & Brava 1.4 (up to Chassis no.4085697)		95-1/96				
Bravo & Brava 1.4 (from Chassis no.4085698)		1/96-				
Cinquecento		94-				
Grande Punto		09/05-	SUOP010VL,R	59.99	SUOP010H	49.99
Punto		93-09/99	SUFI001V	49.99	SUFI001H	39.99
Seicento (Type 187)		98-				
Steyr Puch 500		57-69				
Steyr Puch 500		69-				
Uno (type 146 & 146A) - all models (inc. Turbo) except 45		6/83-8/89				
FORD AMERICA						
Mustang series I - all models		64-70				
Mustang series II - all models		71-73				
FORD AUSTRALIA						
Falcon XK-XP		60-66				
Falcon XK-XP; Ute & Panel Van		60-66				



SHOCK ABSORBERS

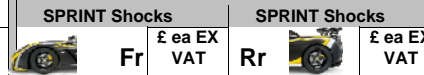



MODEL	Note	YEAR	FRONT		REAR	
			Fr	£ ea EX VAT	Rr	£ ea EX VAT
FORD (BRITISH) COMMERCIAL						
Escort Mk I 6/8 cwt Van		67-74				
Escort Mk II Van		75-80				
Escort Mk III & IV Van		80-8/90	SUFO003V	49.99		
Escort Mk V Van		91-	SUFO0021V	49.99		
FORD EUROPE						
100E Anglia / Prefect (all models)		54-60				
Capri						
Capri Mk I (all models)		69-6/72				
Capri Mk II (all models)		7/72-2/77				
Capri Mk III (all models excl. 2.8 injection)		3/78-88				
Corsair (all models)		63-70				
Cortina						
Cortina Mk I (all models excl. Lotus Cortina)		62-66				
Cortina Mk I - Lotus		64-66				
Cortina Mk I - Lotus: Rear A-frame model	AS	65-66				
Cortina Mk II (all models excl. Lotus Cortina)		9/66-8/70				
Cortina Mk II - Lotus		66-70				
Cortina Mk III/ IV (all models excl. Estates)		09/70-80				
Cortina Mk III/ IV/ V Estates		09/70-82				
Cortina Mk V (all models incl. Estates)		80-82				
Escort Mk I / II						
Escort Mk I (all models incl. Estates)		68-74				
Escort Mk I - late models (all models)		74-75				
Escort Mk II (all models excl. Estates)		75-80				
Escort Mk II Estate		75-80				
Escort Mk II RS models		75-80				
Escort Turret Conversion: Inboard position	AS					
Escort Turret Conversion: Outboard position	AS					
with spherical bearings	AS					



SHOCK ABSORBERS





MODEL	Note	YEAR	SPRINT Shocks		SPRINT Shocks	
			Fr 	£ ea EX VAT	Rr 	£ ea EX VAT
Escort Mk III / IV						
Escort/ Orion Mk III incl. XR3		80-5/83			SUFO003H	39.99
Escort/ Orion Mk III / IV (incl. XR3i/RS Turbo & Cabrio)	(9)	6/83-8/90	SUFO003V	49.99	SUFO003H	39.99
Escort Mk V						
Escort Mk V (excl. Cosworth, Van, Estate) (incl. Cabrio & RS2000)	(9)	9/90-95	SUFO0021V	49.99	SUFO002H	39.99
Escort Mk V Estate (all models)		9/90-95	SUFO0021V	49.99		
Escort Cosworth 4x4		92-96				
Orion Mk V		90-93	SUFO0021V	49.99	SUFO002H	39.99
Escort Mk VI						
Escort Mk VI 3Dr (Type AAL; ABL)		95-	SUFO005V	49.99	SUFO005H	39.99
Escort Mk VI RS2000 4x 4		95-	SUFO005V	49.99		
Fiesta Mk I						
Fiesta Mk I (all models excl. XR2)		76/8-83				
Fiesta Mk I XR2		81-3/83				
Fiesta Mk II						
Fiesta Mk II (all models excl. XR2 & Diesel)		9/83-3/89				
Fiesta Mk II XR2		9/83-3/89				
Fiesta Mk III (Hub Size 43.8mm)						
Fiesta Mk III (All models)		4/89-12/93	SUFO001V	49.99	SUFO001H	39.99
Fiesta Mk III FaceLift FAJ,FBJ,FRJ (Hub Size 45.5mm)						
Fiesta Mk III Face Lift 1.1, 1.3, 1.4, D (NO ANTI-ROLL BAR)	(10)	1/94-96				
Fiesta Mk III Face Lift 1.1, 1.3, 1.4,1.6 (WITH ANTI-ROLL BAR)	(10)	1/94-96				
Fiesta Mk III Face Lift 1.6 Si 16V, XR2i, 1.8RS	(10)	1/94-96				
Fiesta Mk III Face Lift Van (excl. Turbo Diesel or Courier)	(10)	1/94-96				
Fiesta Mk IV & Mk IV Facelift JAS,JBS,JVS						
Fiesta Mk IV A350	(10)	9/95-9/98	SUFO008V	49.99	SUFO008H	39.99
Fiesta Mk IV Facelift. (Rear: Loop damper and parallel spring)	(10)	9/98-02	SUFO008V	49.99	SUFO0081H	39.99
Fiesta Mk IV Facelift. (Rear: Loop damper and pigtail spring)	(10)	00-02	SUFO008V	49.99	SUFO0081H	39.99
Fiesta Mk V						
Fiesta Mk V		11/01-	SUFO012VL/R	59.99	SUFO012H	49.99
Focus						
Focus Saloon & Hatchback (incl. Diesel)		10/98-04	SUFO009VL,R	49.99	SUFO009H	39.99
Focus Estate		10/98-04	SUFO009VL,R	49.99	SUFO0091H	49.99
Focus TDCi Estate		01-04	SUFO009VL,R	49.99	SUFO0091H	49.99



SHOCK ABSORBERS





SPRINT Shocks SPRINT Shocks

MODEL	Note	YEAR	SPRINT Shocks		SPRINT Shocks	
			Fr 	£ ea EX VAT	Rr 	£ ea EX VAT
Granada						
Granada I / Consul (all models incl. Estates)		72-78				
Granada II (all models incl. Estates Excl. Ghia X)		78-4/85				
Granada III (all models incl. Scorpio & 4x4; excl. self levelling rear)		5/85-94				
Ka						
Ka		9/96-10/98	SUFO008V	49.99	SUFO008H	39.99
Ka		11/98-10/02	SUFO008V	49.99	SUFO0081H	39.99
Mondeo						
Mondeo Saloon & Hatchback 1.6; 1.8; 2.0 & TD (excl. EDC)		6/93-9/96				
Mondeo Saloon & Hatchback 1.6; 1.8; 2.0; TD; V6; ST200 (excl. EDC)		10/96-11/00				
Puma						
Puma (Clevis Rear)		9/95-9/98	SUFO008V	49.99	SUFO008H	39.99
Puma (Loop Rear)		10/98-	SUFO008V	49.99	SUFO0081H	39.99
Sierra						
Sierra (excl. XR4 & Estate)		82-5/84				
Sierra & Sapphire (excl. 1300, 4x4, Twin Cam & Estate) - pigtail front springs		6/84-93				
Sierra Estate		82-5/84				
Sierra Estate & 4x4 Estate (excl. Self Levelling Susp.)		6/84-93				
Sierra RS Cosworth (3 door)		86-				
Sierra Sapphire 4x4; XR4x4Cosworth 4x4		90-93				
Sierra Sapphire Cosworth		88-89				
Sierra XR4i		83-5/84				
Sierra XR4i (parallel front springs)		6/84-93				
Sierra XR 4x4 Estate (excl. Self Levelling Susp.)		86-				
Taurus Mk3,4,5 (incl. Estate)		72-82				
GILBERN						
GT models (MGB 1800 engine)		59-66				
Genie (Watts linkage rear suspension)	AS	66-70				
Invader Mk I	AS	66-70				
Invader MK II	AS	71-72				
Invader Mk III	AS	72-74				

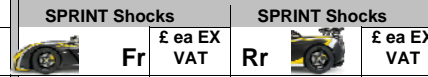

SHOCK ABSORBERS





MODEL	Note	YEAR	SPRINT Shocks		SPRINT Shocks	
			Fr 	£ ea EX VAT	Rr 	£ ea EX VAT
GINETTA						
G11		65-66				
	AS					
G15 (4.75" spring seat height)		68-74				
To chassis no.297						
G21		72-77				
	AS					
G4		61-69				
	AS					
HILLMAN						
See Talbot (UK)						
HONDA						
Civic type EC, ED up to chassis no. S99,999		10/87-88	SUHO001VL,R	39.99	SUHO002H	39.99
up to chassis no. S99,999 (Loop)						
Civic Saloon / Hatch / CRX / CRX V_Tech - type EC, ED, EE8/9		89-12/91	SUHO001VL,R	39.99	SUHO002H	39.99
from chassis no. 100,000 (50mm Clevis)						
Civic Saloon / Hatch / CRX / Coupe (50mm Rear Clevis only)		10/91-9/95	SUHO002VL,R	39.99	SUHO002H	39.99
(incl. V-TEC) type EG2/3/4/5/6/8/9, EH9/6						
Civic 3/4 door & Coupe 1.4-1.6 (40mm Rear Clevis Only)		10/95-2001	SUHO002VL,R	39.99	SUHO003H	39.99
(Not VTi) EK1/3/4, EJ6/8/9						
Civic Coupe; Hatch - type EM2;EP1,2;EU5,6,7,8		02/01-05	SUHO004VL,R	49.99	SUHO004H	39.99
HYUNDAI						
Stellar		83-12/86				
Stellar		01/87-90				
INNOCENTI						
90L; 120L (all models incl. De Tomaso)		74-78				
ISUZU						
Piazza Turbo		80-				



SHOCK ABSORBERS





SPRINT Shocks SPRINT Shocks

MODEL	Note	YEAR	SPRINT Shocks		SPRINT Shocks	
			Fr 	£ ea EX VAT	Rr 	£ ea EX VAT
JAGUAR						
2.4; 3.4; 3.8 litre (240; 340; 380 series models)		60-69				
3.4; 3.8 litre S-type		64-66				
	AS					
420 model		64-66				
	AS					
420 G		66-72				
	AS					
E Type: Drophead; 2+2; Coupe; 6cyl (Excl. V12)		61-72				
Excl USA Models	AS					
E Type: V12 model		71-74				
	AS					
MK VII; VIII; IX		50-61				
MK II 2.4; 3.4 litre		55-67				
MK X 3.8; 4.2 litre		61-66				
	AS					
XK120		49-54				
XK140; XK150		54-61				
XJ6; XJ12		68-10/86				
(2.25" ID Spring Only)	AS					
XJS		75-				
(2.25" ID Spring Only)	AS					
Jaguar IRS with 14" (356mm) Open Length Dampers (no bump stop)	AS					
Jaguar IRS with 13.1" (332mm) Open Length Dampers (no bump stop)	AS					
Jaguar IRS with 13.4" (341mm) Open Length Dampers (with bump stop)	AS					
JENSEN						
CV8		62-68				
Healey		73-75				
Interceptor Series II, III & IV		69-90				
Interceptor (FF model)		66-68				
541S		61				
LADA						
Niva 4x4 (type 2121)		77-91				
VAZ (all models incl. 1200; 1300; 1500)		72-91				
LANCIA						
Beta Coupe, Spyder, HPE		75-84				
Flavia - series I - Saloon & Coupe (1500; 1800; 2000)		62-5/67				
Flavia - series II - Saloon & Coupe (1400; 1600; 1800; 2000)		6/67-8/70				
Fulvia 1100; 1200 / GT; 1300 / GTE (series I - Saloons & Coupes)		63-70				
Fulvia Coupe (series II)		71-75				



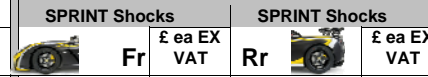

SHOCK ABSORBERS



MODEL	Note	YEAR	SPRINT Shocks		SPRINT Shocks	
			Fr 	£ ea EX VAT	Rr 	£ ea EX VAT
LAND ROVER						
107" / 109" Wheelbase (series I)		53-58				
109" / 119" Wheelbase (series II; IIA; IIB; III)		58-85				
86" / 88" Wheelbase (series II; IIA; IIB; III)		54-85				
Discovery		89-94				
Discovery		94-96				
90 (all models)		84-95				
110 (all models)		83-95				
Range Rover (excl. air suspension)		70-94				
LOTUS						
Eclat (types 520; 521; 522; 523; 524)		75-82				
Elan Coupe +2; S130	AS	67-74				
	AS					
Elan Sprint (series S1; S2; S3; S4)		63-74				
	AS					
Elite I		58-59				
	AS					
Elite II		60-63				
	AS					
Elite III (501; 502; 503; 504)		74-82				
	AS					
Esprit S1; S2 (all models excl. Turbo)		75-80				
	AS					
Esprit S3 (incl. Turbo)		81-85				
	AS					
Esprit Turbo S3		85-87				
	AS					
Esprit Turbo S4		92-96				
Excel I (all models)		82-84				
Europa S1 (all models & S2 with 1.9" I/D springs)		67-69				
	AS					
Europa S2 (2.5" I/D springs)		70-8/71				
	AS					
Europa Twin Cam (2.5" I/D springs)		9/71-75				
	AS	9/71-75				
Excel I (all models)		82-84				
Excel II (SE; SA models)		85-92				





SHOCK ABSORBERS

MODEL	Note	YEAR	SPRINT Shocks		SPRINT Shocks	
			Fr 	£ ea EX VAT	Rr 	£ ea EX VAT
Seven - series I	AS	59-60				
Seven - series II / III	AS	60-70				
Seven - series IV (front antiroll bar mount)	AS	70-75				
MARCOS						
Mantis	AS	70-71				
Mantula - independent rear suspension	AS	89-				
Mini Marcos		65-				
MAZDA						
121 (Rear: Clevis damper)		03/96-10/98	SUFO008V	49.99		
121 (Rear: Loop damper)		11/98-02	SUFO008V	49.99	SUFO0081H	39.99
2		11/01-	SUFO012VL/R	59.99	SUFO012H	49.99
MX 5 - Miata - Eunos		89-97				
MX 5 - Miata - Roadster (Excl. ABS)		98-				
MERCEDES						
180 & 180D		56-62				
190; 190B; 190DB; 190D; 190SL		56-61				
W110; 190; 200; C & D		62-67				
W114/115; all models		68-76				
190						
W201; 190; 190E (Excl. 16V)	(13)	11/82-93				
W201; 190E 2.3 16v & 2.5 16v	(13)	11/82-93				
C Class						
W202; Saloon; Estate	(13)	93-12/95				
W203; Saloon; Estate	(25)	06/00-				
E Class						
W124 4;6cyl (incl. Coupe & Cabriolet) (Excl. T series) (excl. Self Levelling Su	(13)	1/85-05/95				
W210: E-Class (Excl. T series) (excl. Self Levelling Susp.)	(13)	12/95-00				
W211; S211 (excl. EDC)	(25)	03/02-				
SL Class						
W113; 230SL; 250SL & 280SL		63-70				
W107; SL & SLC 6&8 cyl	(13)	74-84				
S Class						
W111; 220B; SB; SE; SEB; SEC; 230 & S		60-67				
W108 250S; SE; 280S; SE		65-72				
W109 300SE; SEL; 3.5; 6.9		65-72				
W126 (excl. Self Levelling Susp.)	(13)	79-90				
W123; C123						
W123; 200 - 230 / D (excl. T series) (excl. Self Levelling Susp.)	(13)	76-84				
C123; 230C; 230CE; 280CE; 300C Turbo-D (excl. Self Levelling Susp.)	(13)	77-85				





SHOCK ABSORBERS

MODEL	Note	YEAR	SUPERSPORT SPRINT Shocks		SUPERSPORT SPRINT Shocks	
			Fr 	£ ea EX VAT	Rr 	£ ea EX VAT
MG						
MG Magnette (types ZA / ZB)		53-59				
MG Midget Mk I	(14)	-64				
MG Midget Mk II / IV	(14)	64-75				
MG Midget Mk V (1500cc models)	(14)	75-79				
MG Sprite Mk I	(14)	-64				
MG Sprite Mk II / IV	(14)	64-75				
MG Sprite Mk V (1500cc models)	(14)	75-79				
MGA	(14)					
MGB / GT - chrome bumper models	(11,14)	62-74				
MGB / GT - rubber bumper models	(12,14)	75-81				
MGC / GT	(11,14)	67-69				
MGF		95-04/02				
MG TF		02/02-				
MINI						
Mini (excl. hydroelastic)		59-				
Mini (hydroelastic)		59-				
Mini (excl. hydroelastic) - lowered suspension		59-				
Mini - use with 1.9" coil springs	AS	59-				
Mini - use with lowered 1.9" coil spring suspension	AS	59-				
Mini - Van / Estate		59-78				
MORGAN						
Plus 4: 4+4; Plus 8		54-91				
Plus 4: 4+4; Plus 8 (rear damper with open length 14.2" (360mm))		91-				
Plus 4: 4+4; Plus 8 (rear damper with open length 11.3" (287mm))		91-				
MORRIS						
See Rover						
NSU						
1000; 1000C; 1000TT; 1000TTS; 1200; 1200TT	AS	61-74				
110; 1200C		66-72				



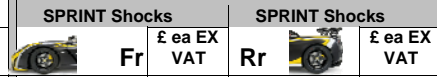

SHOCK ABSORBERS



MODEL	Note	YEAR	SPRINT Shocks		SPRINT Shocks	
			Fr 	£ ea EX VAT	Rr 	£ ea EX VAT
OPEL						
Admiral B		69-78				
Commodore A		67-71				
Commodore B		72-77				
Commodore C		78-82				
Diplomat		69-71				
GT		69-72				
Kapitan		3/69-78				
Monza type A (all models)		78-88				
Senator Mk I Saloon (all models)		78-87				
Senator Mk II Saloon (all models)		9/87-				
Ascona						
Ascona - type A (all models incl. Estates)		70-8/75				
Ascona - type B (all models)		9/76-7/81				
Ascona - type C (all early models excl. Estates)		8/81-8/84				
Ascona - type C (all late models excl. Estates)		9/84-7/88				
Ascona - type C Estate - early models		9/83-8/84				
Ascona - type C Estate - late models		9/84-7/88				
Commodore						
Commodore - type A GS & GS/E		67-71				
Commodore - type B GS & GS/E		72-77				
Commodore - type C		78-82				
Kadett						
Kadett A series (all models)		63-67				
Kadett B series (all models)		65-73				
Kadett C series (all models)		74-79				
Manta						
Manta type A		70-8/75				
Manta type B / CC / CCE (all models incl. GT / E & GSi)		9/75-88				





SHOCK ABSORBERS

MODEL	Note	YEAR	SUPERSPORT SPRINT Shocks		SUPERSPORT SPRINT Shocks	
			Fr 	£ ea EX VAT	Rr 	£ ea EX VAT
Rekord						
Rekord P1; P2		57-63				
Rekord E (all models excl. Estates)		82-8/86				
PEUGEOT						
106 1.1 - 1.4 & 1.4D		91-				
106 Rallye; 1.4 XSi; Quicksilver; Gti		91-				
205 (all models)		2/84-	SUPE001VL,R	49.99	SUPE003H	39.99
206 (all models)		08/98-	SUPE002VL,R	49.99	SUPE002H	39.99
306 (all models)		93-	SUPE003V	49.99	SUPE003H	39.99
307 Saloon; Estate; Cabrio		08/00-	SUPE004V	59.99	SUPE004H	49.99
309 (all models)		87-	SUPE001VL,R	49.99	SUPE003H	39.99
405 (all models excl. 4x4)		87-				
PIPER						
GTT (all models)	AS	67-71				
P2 (all models)	AS	71-74				
PORSCHE						
356 A; B; C		56-65				
911 series B, C & D (types 911S; 911T) excl. hydromat - Boge Strut		9/68-12/72				
911 series E (types 911; 911S) - Boge Strut		9/71-74				
911 Carrera RS; 3.0 Turbo; 3.2 Turbo; 3.3 Turbo S; 3.2 SC - Boge Strut		71-89				
912 series B		65-70				
914		69-76				
924 (all models incl. Turbo)		11/75-8/84				
924 Carrera GT		06/80-08/84				
924S		9/84-7/87				
944 (all models excl. S2 & Turbo)		81-8/84				
944 (excl. Turbo)		9/84-87				
RANGE ROVER						
Range Rover (excl. air suspension)		70-94				



SHOCK ABSORBERS





MODEL	Note	YEAR	SPRINT Shocks		SPRINT Shocks	
			Fr 	£ ea EX VAT	Rr 	£ ea EX VAT
RELIANT						
Scimitar GT - Straight 6 model		64-66				
	AS					
Scimitar GT - V6 model		66-75				
	AS					
Scimitar GTE; GTC; 5; 5A; 6; 6A		68-				
Scimitar GTE; GTC; 5; 5A; 6; 6A (2.5" ID rear springs)	AS	68-				
Scimitar GTE; GTC; 5; 5A; 6; 6A (2.25" ID rear springs)	AS	68-				
SS1 1300; 1600; 1800Ti (2.25" Rear Spring)	AS	85-				
RENAULT						
Alpine A108; A110		60-75				
Alpine A110B; 1600SC	AS	74-76				
Alpine A310 Coupe (types VE; VF)	AS	71-75				
Alpine A310 Coupe V6-I (3 bolt wheels)		6/76-81				
	AS					
Alpine A310 Coupe V6-II (4 bolt wheels)		81-84				
	AS					
Alpine V6 Turbo		85-91				
R3/R4 (all models)		6/61-9/68				
R4 (all models)		9/68-86				
R4 Van (all models)		9/68-86				
R5 (all models excl. Alpine / Turbo)		72-84				
R5 Alpine (type R8220)		76-83				
R5 Mid-Engine Turbo (type R8220)	AS	80-85				
R5 GT Turbo type C405: Phase 1 (up to F 02 7412K 0257635)		85-6/87				
R5 GT Turbo type C405: Phase 2 (from F 02 7413/K 0257636)		7/87-90				
R6 (types R1180; 1181)		69-79				
R8/R10 (types R1130; 1131; 1132; 1190; 1192)		2/62-71				
R8 Gordini		10/64-69				
R9 (all models excl. GTX / TXE - type L426)		9/81-89				
R19 1.4 - 1.6 (with 2 torsion bars) exc. RSi 8v	(22)	88-95	SURE001V	49.99		
R19 1.4 - 1.8 incl. Cabrio (with 4 torsion bars) exc. RSi 8v	(22)	88-95	SURE001V	49.99	SURE001H	49.99
R19 16v & Cabrio		89-			SURE001H	49.99
Clio 1.1; 1.2 & 1.4 (52mm Bolt Spacing on Front Strut)	(16)	90-07/97	SURE004V	49.99	SURE004H	39.99
Clio 1.2; 1.4; 1.7; 1.8; 1.9D; 1.8 RSi (not Van) (54mm Bolt Spacing on Front Strut)	(16)	90-07/97	SURE0041V	49.99	SURE004H	39.99
Clio 1.8i 16v		91-98			SURE004H	39.99
Clio Williams		91-98			SURE004H	39.99





SHOCK ABSORBERS



MODEL	Note	YEAR	SPRINT Shocks		SPRINT Shocks	
			Fr 	£ ea EX VAT	Rr 	£ ea EX VAT
Clio 2 1.1; 1.2; 1.4 (52mm Bolt Spacing on Front Strut)	(16)	03/98-12/05	SURE003V	49.99	SURE003H	39.99
Clio 2 1.2; 1.4; 1.6; Diesel (58mm Bolt Spacing on Front Strut)	(16)	03/98-12/05	SURE0031V	49.99	SURE003H	39.99
Clio 2.0 16v Sport;172 (54mm Bolt Spacing on Front Strut, 25mm between brackets)		02/00-12/05				
Clio 2.0 182 (60mm Bolt Spacing on Front Strut)		02/00-12/05				
Megane Saloon; Classic (type BA; LA) 1.4-2.0 (excl 16V)		96-10/02	SURE0023V	49.99	SURE002H	39.99
Megane Saloon; Classic (type LA) 2.0 16V		07/96-10/98	SURE002V	49.99	SURE002H	39.99
Megane Saloon; Classic (type LA) 2.0 16V		11/98-	SURE0021V	49.99	SURE002H	39.99
Megane Coupe & Cabrio (type DA; EA) 1.4-2.0 (excl 16V)		03/96-	SURE0023V	49.99	SURE002H	39.99
Megane Coupe & Cabrio (type DA; EA) 2.0 16V		03/96-10/98	SURE002V	49.99	SURE002H	39.99
Megane Coupe & Cabrio (type DA; EA) 2.0 16V		11/98-	SURE0021V	49.99	SURE002H	39.99
Megane Scenic (type JA) 1.4; 1.6 Manual		01/96-10/98	SURE0023V	49.99	SURE0021H	39.99
Megane Scenic (type JA) 1.6 Auto; 2.0; 1.9 Diesels		01/96-10/98	SURE0021V	49.99	SURE0021H	39.99
Megane Scenic (type JA) 1.4; 1.6; 2.0; 1.9 Diesels		07/98-	SURE0023V	49.99	SURE0021H	39.99
Megane (type M)		11/02-	SURE005V	59.99	SURE005H	49.99
Twingo		92-				
ROVER						
100 (Metro)		90-98				
25 (Type RF)		99-				
Austin / Morris 1000 Saloon	(14)	64-68				
Maestro / Montego (all models excl. Van)	AS,(16)	3/83-91				
Maestro MG EFI	AS	85-91				
Marina / Ital (all models)		71-84				
Metro (all models)		80-98				
Metro Challenge		80-90				
MG Magnette (types ZA / ZB)		53-59				
MG Midget Mk I	(14)	-64				
MG Midget Mk II / IV	(14)	64-75				
MG Midget Mk V (1500cc models)	(14)	75-79				
MG Sprite Mk I	(14)	-64				
MG Sprite Mk II / IV	(14)	64-75				
MG Sprite Mk V (1500cc models)	(14)	75-79				
MGA	(14)					
MGB / GT - chrome bumper models	(11,14)	62-74				
MGB / GT - rubber bumper models	(12,14)	75-81				
MGC / GT	(11,14)	67-69				
MGF		95-01				
MG TF		02/02-				





SHOCK ABSORBERS

MODEL	Note	YEAR	SPRINT Shocks		SPRINT Shocks	
			Fr 	£ ea EX VAT	Rr 	£ ea EX VAT
SEAT						
124 (all models excl. Estate & Coupe)		67-80				
124 Estate		67-80				
131 Mirafiori (all models excl. Estates)		75-				
131 Mirafiori Estate		75-				
850; 133		65-76				
Altea (Front Strut Diameter 50mm (1.96"))		03/04-	SUVW008V	59.99	SUVW008H	49.99
Altea (Front Strut Diameter 55mm (2.15"))		03/04-	SUVW0081V	59.99	SUVW008H	49.99
Arosa type 6H		97-	SUVW002V	49.99	SUVW006H	39.99
Cordoba - type 6K; 6K/C		8/93-09/02	SUVW002V	49.99	SUVW001H	39.99
Cordoba - type 6L		01/02-	SUVW010V	49.99	SUVW010H	39.99
Ibiza - type 6K; 6K/C		4/93-01/02	SUVW002V	49.99	SUVW001H	39.99
Ibiza - type 6L		02/02-	SUVW010V	49.99	SUVW010H	39.99
Leon - type 1M	(17)	09/98-2005	SUVW004V	49.99	SUVW0041H	39.99
					SUVW004H	49.99
Leon 4x4 - type 1M	(17)	02/01-	SUVW004VQ	49.99	SUVW004HQ	49.99
Leon (Front Strut Diameter 50mm (1.96"))		09/05-	SUVW008V	59.99	SUVW008H	49.99
Leon (Front Strut Diameter 55mm (2.15"))		09/05-	SUVW0081V	59.99	SUVW008H	49.99
Toledo - type 1L		3/91-94	SUVW002V	49.99		
					SUVW002H	39.99
Toledo - type 1M	(17)	09/98-	SUVW004V	49.99	SUVW0041H	39.99
					SUVW004H	49.99
Toledo (Front Strut Diameter 50mm (1.96"))		10/04-	SUVW008V	59.99	SUVW008H	49.99
Toledo (Front Strut Diameter 55mm (2.15"))		10/04-	SUVW0081V	59.99	SUVW008H	49.99
SKODA						
1000 MB; 1100 MB		64-70				
105; S110; S120; 130		70-90				
Fabia - type 6Y		01/00-	SUVW010V	49.99	SUVW010H	39.99
Octavia type 1U	(17)	9/97-04	SUVW004V	49.99	SUVW0041H	39.99
					SUVW004H	49.99
Octavia (Front Strut Diameter 50mm (1.96"))		06/04-	SUVW008V	59.99	SUVW008H	49.99
Octavia (Front Strut Diameter 55mm (2.15"))		06/04-	SUVW0081V	59.99	SUVW008H	49.99
Superb - type 3U		02/02-	SUAU003V	49.99	SUAU005H	49.99





SHOCK ABSORBERS

MODEL	Note	YEAR	SPRINT Shocks		SPRINT Shocks	
			Fr 	£ ea EX VAT	Rr 	£ ea EX VAT
TALBOT (FRANCE) (CHRYSLER / SIMCA)						
Matra Murena	AS	2/81-83				
Simca 1000 Rallye I "F" Chassis; 1200S Coupe		67-73				
Simca 1000 Rallye II		73-79				
Simca 1300; 1500 (to Chassis no: L080587)		9/63-9/64				
Simca 160; 180; 2-litre Boge front suspension		70-80				
Simca 160; 180; 2-litre Sachs front suspension		70-80				
Simca 900; 1000 (to chassis no: 180643)		62-73				
Simca 900; 1000 (from chassis no: 180644)		62-73				
Talbot Samba (all models excl. Rallye)		10/81-85				
TALBOT (UK)						
Hillman Avenger (all models incl. Estates)		70-10/77				
Hillman Avenger (all models incl. Estates)		11/77-				
Hillman Hunter - all models excl. Estates		66-79				
Hillman Hunter Estates		70-76				
Hillman Imp - for use with lowered suspension		63-76				
	AS					
Hillman Imp - for use with standard suspension		63-76				
	AS					
Hillman Minx - early models (series I-IIIC)		56-63				
Hillman Minx Mk V-VI		63-67				
Hillman Minx Mk VII (all models excl. Estates)		67-70				
Hillman Minx Mk VIII Estate		8/67-70				
Hillman Vogue Mk I-IV (all models)		61-67				
Hillman Vogue (all models excl. Estates)		67-70				
Hillman Vogue Estate - late models		67-70				
Sunbeam Alpine Mk I/II		59-63				
Sunbeam Alpine Mk III		63				
Sunbeam Alpine Mk IV		64-9/65				
Sunbeam Alpine Mk V		10/65-68				
Sunbeam Alpine Mk VI Fastback Coupe		69-76				
Sunbeam Gazelle - early models (Mk V & VI)		63-67				
Sunbeam Gazelle - late models		66-70				
Sunbeam Rapier Mk IV-V		63-67				
Sunbeam Rapier Mk VI-VII		67-76				
Sunbeam Sceptre Mk I-II		63-67				
Sunbeam Sceptre (all models excl. Estates)		67-79				
Sunbeam Sceptre Estate		10/74-79				
Sunbeam Tiger		64-68				
Talbot Sunbeam (all models excl. Ti & Lotus)		79-81				
Talbot Sunbeam Ti & Lotus		79-81				





SHOCK ABSORBERS

MODEL	Note	YEAR	SUPERSPORT SPRINT Shocks		SUPERSPORT SPRINT Shocks	
			Fr 	£ ea EX VAT	Rr 	£ ea EX VAT
TOYOTA						
Celica 1600ST; 2000ST (types TA60; RA60)		8/81-85				
Celica 2000XT; ST; GT; 1600GT; GTS (type RA61;RA63;AA63;SA63;RA65)		8/81-85				
Celica 2800 Supra (type MA61)		12/81-5/83				
Celica 2800 Supra (type MA61)		6/83-12/85				
Corolla 1300; 1500; 1600; 1800;		8/79-10/84				
Diesel - (types KE70; AE70; 71; TE71; 72; CE70)						
Corolla 1600 RWD (incl. GTi 16v) (type AE86)		5/83-5/87				
MR2 Mk 2 2000 TC type SW20 (excl. Turbo) - rebuildable O.E. dampers only		90-94				
RAV4		95-01				
Tercel 1450-AL25 series (4x4)		9/82-88				
Yaris		99-08/05				
TRIUMPH						
1500; 1500TC		8/70-3/76				
2000; 2500 Saloon / Estate (all models incl. PI & TC)		63-77				
Dolomite Saloon (all models incl. Sprint)		72-80				
	AS					
	(20)					
GT6 Mk I; Mk 3 (Non Rotoflex)		66-68				
	AS					
GT6 Mk II; Mk 3 (Rotoflex)		68-70				
	AS					
Herald Saloon / Coupe (all models)		59-71				
	AS					
Spitfire Mk I / II / III / IV (all models)		62-80				
	AS					
STAG (all models)		70-77				
TR2; 3; 3A; 4		52-65				
TR4A; 5; 6		64-75				
TR7; TR8 (all models)		75-81				
Toledo		8/70-3/76				
Vitesse Mk I 1600; 2000		62-68				
	AS					
Vitesse Mk II 2000		68-71				
	AS					







SHOCK ABSORBERS

MODEL	Note	YEAR	SUPERSPORT SPRINT Shocks		SUPERSPORT SPRINT Shocks	
			Fr 	£ ea EX VAT	Rr 	£ ea EX VAT
TVR						
1600M; 2500M -2" i/d springs	AS	72-77				
1600M; 2500M - 2.25" i/d springs	AS	72-77				
1600M; 2500M - 2.5" i/d springs	AS	72-77				
1600M; 2500M - 2.75" i/d springs	AS	72-77				
3000M: TAIMAR - 2" i/d springs	AS	72-79				
3000M: TAIMAR - 2.25" i/d springs	AS	72-79				
3000M: TAIMAR - 2.5" i/d springs	AS	72-79				
3000M: TAIMAR - 2.75" i/d springs	AS	72-79				
Chimera	AS	93-				
Grantura 1800S	AS	64-67				
Grantura Mk III	AS	62-64				
Griffith 200 / 400 V8 2" i/d springs	AS	63-65				
Griffith 200 / 400 V8 2.25" i/d springs	AS	63-65				
Griffith 200 / 400 V8 2.5" i/d springs	AS	63-65				
Griffith200 / 400 V8 2.75" i/d springs	AS	63-65				
Griffith	AS	93-				
S: SE Convertible	AS	86-				
Tasmin 280i; 350i; 390i / SE; 420SE (all models)	AS	80-				
Tasmin 420 SEAC	AS	87-				
	AS					





SHOCK ABSORBERS

			 SPRINT Shocks		 SPRINT Shocks	
MODEL	Note	YEAR	 Fr	£ ea EX VAT	 Rr	£ ea EX VAT
Tuscan V6 - 2" i/d springs	AS	69-71				
Tuscan V6 - 2.25" i/d springs	AS	69-71				
Tuscan V6 - 2.5" i/d springs	AS	69-71				
Tuscan V6 - 2.75" i/d springs	AS	69-71				
Tuscan V8; V8-SE - 2" i/d springs	AS	67-68				
Tuscan V8; V8-SE - 2.25" i/d springs	AS	67-68				
Tuscan V8; V8-SE - 2.5" i/d springs	AS	67-68				
Tuscan V8; V8-SE - 2.75" i/d springs	AS	67-68				
Vixen S1 / S2 / S3 / S4 - 1300 / 2500 2" i/d springs	AS	67-73				
Vixen S1 / S2 / S3 / S4 - 1300 / 2500 2.25" i/d springs	AS	67-73				
Vixen S1/ S2/ S3/ S4 - 1300 / 2500 2.5" i/d springs	AS	67-73				
Vixen S1/ S2/ S3/ S4 - 1300 / 2500 2.75" i/d springs	AS	67-73				



SHOCK ABSORBERS





MODEL	Note	YEAR	SPRINT Shocks		SPRINT Shocks	
			Fr 	£ ea EX VAT	Rr 	£ ea EX VAT
VAUXHALL						
Royale Coupe		78-82				
Senator Mk I Saloon (all models)		78-87				
Senator Mk II Saloon (all models)		9/87-				
Viceroy Saloon		80-82				
Astra						
Astra Mk I (all models excl. Estates)		8/79-9/84	SUOP004V	49.99	SUOP002H	39.99
Astra Mk I Estate (all models)		8/79-9/84	SUOP004V	49.99	SUOP004H	39.99
Astra Mk II 1.3; 1.4 (all models excl. GTE/GSi; Estates)		10/84-8/91	SUOP004V	49.99	SUOP002H	39.99
Astra Mk II Estate 1.3-2.0		10/84-8/91	SUOP004V	49.99	SUOP004H	39.99
Astra Mk II GTE/GSi (incl. 16v)		86-91	SUOP004V	49.99	SUOP002H	39.99
Astra Mk III (all models excl. Estates)		9/91-2/98	SUOP002V	49.99	SUOP002H	39.99
Astra Mk III Estate		9/91-	SUOP002V	49.99	SUOP004H	39.99
Astra G 1.6-2.0; Diesel (excl. Estate, Coupe, Van)		98-	SUOP006VL,R	49.99	SUOP006H	39.99
Astra G 2.0 & Dsl (excl. Estate, Coupe, Van)		98-	SUOP006VL,R	49.99	SUOP006H	39.99
Astra G Coupe 1.6, 1.8 2.2, DTi; Cabrio		00-	SUOP006VL,R	49.99	SUOP006H	39.99
Astra G Estate; Van		98-	SUOP006VL,R	49.99	SUOP011H	39.99
Astra H Hatch; Estate; GTC		03/014-	SUOP009VL,R	59.99	SUOP009H	49.99
Belmont Saloon 1.3; 1.4		85-91	SUOP004V	49.99	SUOP002H	39.99
Calibra						
Calibra 2.0i; 2.0i 16v; 4cyl Turbo; 6cyl; 4x4		6/90-	SUOP003V	49.99	SUOP003H	39.99
Carlton						
Carlton Mk I (all models excl. Estates)		7/77-8/86				
Carlton Mk II 4 & 6cyl (all models excl. Estates) Active Suspension		9/86-				



SHOCK ABSORBERS





MODEL	Note	YEAR	SPRINT Shocks		SPRINT Shocks	
			Fr 	£ ea EX VAT	Rr 	£ ea EX VAT
Cavalier						
Cavalier Mk I - RWD (all models)		8/75-7/81				
Cavalier Mk II - (all early models excl. Estates)		8/81-8/84				
Cavalier Mk II - (all late models excl. Estates)		9/84-7/88				
Cavalier Mk II Estate - early models		9/83-8/84				
Cavalier Mk II Estate - late models		9/84-7/88				
Cavalier Mk III - 1.6-2.0+Dsl (Excluding V6 and 4x4)		8/88-95	SUOP003V	49.99	SUOP002H	39.99
BEAM REAR AXLE ONLY						
Cavalier Mk III - 2.0 16v 2wd; 4wd (Ch. No. N.....)	(15)	8/88-92	SUOP003V	49.99		
INDEPENDENT REAR SUSPENSION ONLY						
Chevette						
Chevette Hatchback; Estate; Van (excl. HS2300)		75-84				
Chevette Saloon (all models)		5/76-84				
Corsa						
Corsa B (All models)		3/93-2000	SUOP001V	49.99	SUOP001H	39.99
Corsa C 1.0; 1.2 (WITHOUT Sport Susp. & M10 rear damper eye)		01-	SUOP007VL,R	59.99		
Corsa C 1.0; 1.2 (WITH Sport Susp. & M14 rear damper eye)		01-	SUOP007VL,R	59.99		
Corsa C 1.7Di (WITHOUT Sport Susp. & M10 rear damper eye)		01-	SUOP007VL,R	59.99		
Corsa C 1.4; 1.8; 1.7Di&DTi (WITH Sport Susp. & M14 rear damper eye)		01-	SUOP007VL,R	59.99		
Corsan D (all models)		07/06-	SUOP010VL,R	59.99	SUOP010H	49.99
Meriva						
Meriva type X01		05/03-	SUOP007VL,R	59.99	SUOP009H	49.99
Nova						
Nova (all models)		8/83-2/93	SUOP001V	49.99	SUOP001H	39.99
Signum						
Signum type Z-C/S		05/03-	SUOP008VL,R	59.99	SUOP008H	49.99
Tigra						
Tigra 1.4i/16V; 1.6i 16V		9/94-04	SUOP001V	49.99	SUOP001H	39.99
Twintop Roadster (Rear Damper with M10 eye)		06/04-	SUOP007VL,R	59.99	SUOP001H	39.99
Twintop Roadster (Rear Damper with M14 eye)		06/04-	SUOP007VL,R	59.99	SUOP007H	39.99



SHOCK ABSORBERS





MODEL	Note	YEAR	SPRINT Shocks		SPRINT Shocks	
			Fr 	£ ea EX VAT	Rr 	£ ea EX VAT
Vectra						
Vectra B Saloon from Ch. no.T1086824 (excl. Self Levelling Susp.)		9/96-04/02	SUOP005VL,R	49.99	SUOP005H	39.99
Vectra B Estate from Ch. no.T1086824 (excl. Self Levelling Susp.)						
Vectra B Estate from Ch. no.T1086824 (excl. Self Levelling Susp.)		9/96-04/02	SUOP005VL,R	49.99	SUOP005H	39.99
Vectra C Saloon; Estate; GTS		04/02-	SUOP008VL,R	59.99	SUOP008H	49.99
Viva						
Viva HA (all models incl. Estates)		63-66				
Viva HB - early models (all models excl. Estates) to Chassis no. 158035		67-70				
Viva HB - late models (all models excl. Estates) from Chassis no. 158036		67-70				
Viva HB Estate - early models (all models to Chassis no. 158035)		67-70				
Viva HB Estate - late models (all models from Chassis no. 158036)		67-70				
Viva HC Firenza (all models)		71-79				
Viva Magnum		73-78				
Zafira						
Zafira 1 type T98		04/99-	SUOP006VL,R	49.99	SUOP011H	39.99
Zafira 2 type A-H		07/05-	SUOP009VL,R	59.99	SUOP011H	39.99
VOLKSWAGEN						
1500S; 1600 Saloon/Variant (all models)		6/62-7/67				
1600 Saloon/Variant (all models)		8/67-73				
Beetle						
Beetle 1200		3/53-				
Beetle 1200; 1300A; 1500A; Karmann Ghia (all models - rear swing axle)		8/65-79				
Beetle 1300A; 1500A; Karmann Ghia (all models - dual joint rear axle)						
Beetle 1300A; 1500A; Karmann Ghia (all models - dual joint rear axle)		5/67-79				
Beetle 1302; 1302S; 1302LS; 1303; 1303S (strut front)						
Beetle 1302; 1302S; 1302LS; 1303; 1303S (strut front)		8/70-79				
New Beetle						
New Beetle (Excl. 4Motion & RSi)	(17)	98-	SUVW004V	49.99	SUVW0041H	39.99
					SUVW004H	49.99
Bora						
Bora	(17)	09/98-	SUVW004V	49.99	SUVW0041H	39.99
					SUVW004H	49.99
Camper						
Type2 std Height		65-79				
Type2 up to 100mm Lower		65-79				
Type2 up to 200mm Lower		65-79				
Type2 Height adjustable	AS	65-79				
Type2 Height adjustable	AS	65-79				
Corrado						
Corrado (type 53i)		10/91-	SUVW005V	49.99		
Eos						
Eos Cabrio		03/06-	SUVW008V	59.99	SUVW008H	49.99
Eos Cabrio		03/06-	SUVW0081V	59.99	SUVW008H	49.99





SHOCK ABSORBERS



MODEL	Note	YEAR	SPRINT Shocks		SPRINT Shocks	
			 Fr	£ ea EX VAT	Rr 	£ ea EX VAT
Fox						
Fox (type 5Z)		04/05-	SUVW010V	49.99	SUVW010H	39.99
Golf I / Jetta / Caddy						
Golf I / Jetta	(16)	9/79-8/83	SUVW001V	49.99	SUVW001H	39.99
Caddy	(16)		SUVW001V	49.99		
Golf II / Jetta						
Golf II / Jetta (excl. 16V; G60; 4x4) (Non sealed Strut)	(16)	9/83-92			SUVW002H	39.99
Golf II / Jetta (excl. 16V; G60; 4x4) (Sealed Strut)	(16)	9/83-92	SUVW002V	49.99		
Golf II / Jetta GTi 16v & G60 (Non Sealed Strut)	(16)	90-91			SUVW002H	39.99
Golf II / Jetta GTi 16v & G60 (Sealed Strut)	(16)	90-91	SUVW002V	49.99		
Golf II / Jetta Synchro 4x4 (Non Sealed Strut)	AS,(19)	85-92				
Golf II / Jetta Synchro 4x4 / Rallye (Sealed Strut)	AS,(19)	85-92	SUVW002V	49.99		
Golf III / Vento						
Golf III / Vento (excl. 16V; G60; 4x4)		9/91-9/94	SUVW002V	49.99	SUVW002H	39.99
Golf III / Vento GTi 16V; VR6 2wd	(16)	9/94-9/97	SUVW002V	49.99		
Golf III Cabrio		07/93-10/94	SUVW002V	49.99		
Golf III Estate		12/93-8/94	SUVW002V	49.99	SUVW009H	49.99
Golf IV						
Golf IV Hatch; Estate	(17)	10/97-	SUVW004V	49.99	SUVW0041H	39.99
Golf IV Cabrio	(17)	06/98-	SUVW002V	49.99	SUVW004H	49.99
Golf IV 4 Motion (4x4)	(17)	07/99-	SUVW004VQ	49.99	SUVW002H	39.99
Golf V / Golf Plus / Jetta / Touran						
Golf 5/Golf Plus/Jetta/Touran (Front Strut Diameter 50mm (1.96"))		11/03-	SUVW008V	59.99	SUVW008H	49.99
Golf 5/Golf Plus/Jetta/Touran (Front Strut Diameter 55mm (2.15"))		11/03-	SUVW0081V	59.99	SUVW008H	49.99
Lupo						
Lupo (type 6X;6E;6ES) 1.0;1.4;1.416V;1.4FiS;1.4TDi;1.7SDi;1.6GTi		06/98-	SUVW002V	49.99	SUVW006H	39.99



SHOCK ABSORBERS

MODEL	Note	YEAR	SPRINT Shocks		SPRINT Shocks	
			Fr 	£ ea EX VAT	Rr 	£ ea EX VAT
Passat						
Passat Mk II (all models excl. Synchro 4x4)		10/80-3/88	SUAU001V	49.99		
Passat Mk III Type 35i (excl. Air Suspension)		4/88-92	SUVW002V	49.99		
Passat Mk III Type 35i (excl. Air Suspension)		9/92-9/96	SUVW005V	49.99	SUVW005H	39.99
Passat - type 3B		10/96-00	SUAU003V	49.99	SUVW005H	39.99
Passat - type 3C		03/05-	SUVW0081V	59.99	SUAU005H	49.99
Polo						
Polo I / II / III (INCL. G40) / Derby		8/76-7/94	SUVW003V	49.99	SUVW008H	49.99
Polo IV Type 6N 1.0-1.6; 1.4TDi; 1.9SDi; GTi (excl. Classic)		9/94-10/99	SUVW003V	49.99	SUVW003H	39.99
Polo IV Type 6N 1.0-1.6; 1.4TDi; 1.9SDi; GTi (excl. Classic)		9/94-10/99	SUVW002V	49.99	SUVW001H	39.99
Polo V Type 6N/2		11/99-01/02	SUVW002V	49.99	SUVW001H	39.99
Polo VI Type 9N		10/01-	SUVW010V	49.99	SUVW010H	39.99
Scirocco						
Scirocco		74-90	SUVW001V	49.99		
					SUVW001H	39.99
VOLVO						
140; 160 series (all models incl. Estates)		9/71-74				
240; 260 series (all models incl. Estates)		6/88-				
DAF 66 DL; GL		75-				
P-series PV444; PV544		45-66				
P-series PV445; PV210 Duett		57-63				
P-series P120; P130 series Amazon (excl. Estates)		61-73				
P-series P1800 Coupe		62-70				
P-series P220 series Amazon Estate		9/71-8/74				
WESTFIELD						
All Car Engine models	AS					



Notes



TSX SPRINT TOP ADJUSTABLE STRUTS AND INSERTS

- TAG** Top adjustable strut or strut insert
TAS Top adjustable strut or strut insert - Extra Short for Extreme (50+mm) Lowering
-I Strut insert
TAAS RSX Kit Height and Damping Adjustable Strut

GSX SPRINT GAS ADJUSTABLE DAMPERS

- G...EA** Shortened by approximately 40mm (versus 20mm) for Extreme (50+mm) Lowering
G...AS With **adjustable ride height**

Loop Fitting



Stem Fitting



Clevis Fitting



Parallel Spring



Pigtail Spring



SUSPENSION NOTES

AS The Telescopic Dampers are height adjustable using a threaded sleeve, a spring seat and a lock ring. C spanners are required.

- Shortened Dampers should be used to avoid damage and possible accident
- Not suitable for cars fitted with Sports Suspension, Bad Road Suspension or Self Levelling Suspension.
- Complete kits must be supplied if car is fitted with Sport Suspension.
- Fronts and kits will not fit cars with front anti roll bar attached to the strut body.
- 2 Springs in this kit
- Only for M-Technik or M Sport suspension
- Not suitable for cars fitted with M-Technik or Self Levelling Suspension or EDC.
- TAG1058 has M12 top nut & 40mm dust cover, TAG1059 has M12 top nut and 80mm dust cover, TAG1060 has M14 top nut and 80mm dust cover
- Will require recalibration of mechanical ABS
- Do not confuse Fiesta 3, Fiesta 3 Facelift, Fiesta 4 and Fiesta 4 Facelift. Use the list below to check vehicle.

CHECK:

Fiesta 3	89-12/93, types FAJ & FBJ (Front: 43.8mm Hub Diameter)
Fiesta 3 Facelift	01/94-96, types FAJ & FBJ (Front: 45.5mm Hub Diameter)
Fiesta 4	09/95-09/98 JAS & JBS (Rear: Clevis bottom fixing with a parallel spring)
Fiesta 4 Facelift	09/98-05/00 JAS & JBS (Rear: Loop bottom fixing with a parallel spring)
Fiesta 4 Facelift	05/00-02 JAS & JBS (Rear: Loop bottom fixing with a pigtail spring)

Use the table below to find the date of manufacture. This is done by using the 11th and 12th character of the VIN.

YEAR=11th CODE	MONTH= 12th CODE												
	01	02	03	04	05	06	07	08	09	10	11	12	
1983	D	C	K	D	E	L	Y	S	T	J	U	M	P
1989	K	J	U	M	P	B	R	A	G	C	K	D	E
1993	P	J	U	M	P	B	R	A	G	C	K	D	E
1994	R	L	Y	S	T	J	U	M	P	B	R	A	G
1995	S	C	K	D	E	L	Y	S	T	J	U	M	P
1996	T	B	R	A	G	C	K	D	E	L	Y	S	T
1998	W	L	Y	S	T	J	U	M	P	B	R	A	G
2001	1	J	U	M	P	B	R	A	G	C	K	D	E

e.g. SFABXXBAFBRJ84569 11th=R and 12th=J, so date of manufacture is 05/94.

(13) On some Mercedes applications rubber spacers are used between the spring and vehicle body. If your intended application has these spacers fitted then you should use spacers marked with one "dot" to get the lowest ride height. Thicker spacers are fitted to vehicles that have air conditioning and automatic gearboxes (3-4 dots on the front), or that are used with trailers (3 dots at the rear).

(14) A Conversion Kit contains all the necessary fixings, bracketry and dampers to convert from O.E. lever arm dampers to SPAX Telescopic Dampers.

(15) This kit is suitable for all cars fitted with independent rear suspension, e.g. 1.8/2.0 4x4 GL; 2.0 16v SRi & GSi; 2 & 4wd Turbo.

#REF!



Notes



(16) See drawings below.

(17) At over 50mm lowering at the front, a modified anti roll bar LINK is required to prevent fouling. These are available from SPAX. Struts will not fit cars with the anti roll bar link attached to the strut.

(18) Check the internal diameter of the pigtail (smaller diameter coil at the top) on the front spring. This will be either 65mm or 81mm.

(19) The G453, G574-AS and G841AS must be used with a 2 1/4" parallel spring.

(20) The G698 has its spring seat set 25mm lower than O.E.

(21) Front dampers changed in February 2002. Any car with Chassis Number BEFORE TC32197 must be checked. BMW may have changed the front Dampers under Warranty from "EARLY" to "LATE" Suspension. If the anti roll bar mounts on the Spring Pan, it is "EARLY" suspension (before 03/2002)

(22) Rear Torsion bar is either a single tube mounted across the rear, above the exhaust (2 Torsion Bar Type), or 2 tubes mounted across the rear, above the exhaust (4 Torsion Bar Type)

(23) With Air Suspension

(24) Without Air Suspension

(25) Not suitable for cars fitted with EDC (Electronically Adjusted Dampers)

EXHAUST NOTES

- Only with pivot bearing on upper suspension strut
- Not suitable standard sport susp.
- R32 look, fits rear bumper of R32
- Double-exit, tailpipe version X...not available
- Duplex system with two silencers
- 76mm (3 inch) diameter
- Center-exit
- Without Ecotec, not for live axle
- Exhaust system without bikat
- Only tube, no silencer
- Only for bumpers with M-technik
- System for 54mm dia. of tube
- Only with double tube entrance
- Duplex - without additive strut on axle
- Diagonal silencer
- Diagonal silencer for Duplex systems
- Only with single tube entrance
- System with 50.8mm tube dia.
- With plug connection (socket)
- Only with tailpipe guide under bumper (also spoiler bumper)
- With center-exit, Cooper S-Look
- Connecting flange with two holes
- Connecting flange with three holes
- Only for models without auxiliary heating
- Mounting with body clamp
- 3-point mounting
- Only for 8 valve engines
- OPC with center-exit
- Not 4x4, backsilencer without Ecotec
- No Duplex possible with balance weight on rear
- Only for models with double pipe
- 50mm connecting tube
- 65mm connecting tube
- Silencer only for 8 Valve engines
- 54mm connecting tube
- Bumper must be cut
- Only BiKat
- Not for Bikat
- Incl. Gfk
- Duplex - Spare wheel not possible
- Specify if bumper is to be cut or not

Note 16

Honda Civic Rear

Please check the clevis spacing on the rear damper and check against the listings to ensure the correct dampers/kits are ordered.

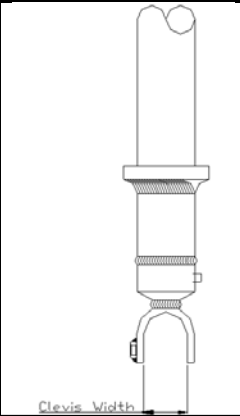
Clevis Width	SPAX Part Number	
50mm	G2046	
40mm	G2086	

Rover Maestro/Montego Front

Please check the spring pan height on the front strut and check against the listings to ensure the correct dampers/kits are ordered.

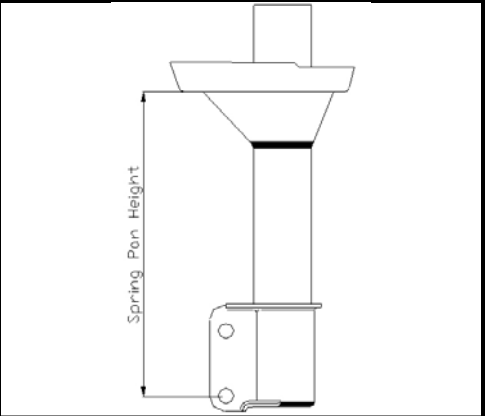
Spring Pan Height	Spax Part Number	
264mm	TAG1029	
250mm	TAG1047	

Renault Clio 1 & 2

Please check the bolt spacing on the front strut and check against the listings to ensure the correct dampers/kits are ordered.

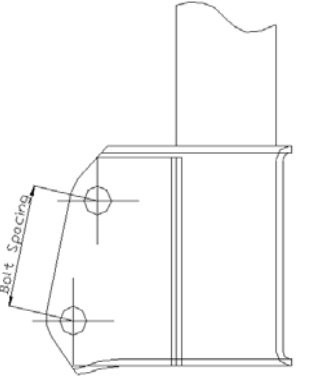
Car	Year	Bolt Spacing	SPAX Part Number	
Clio 1. 1.1-1.4	90-07/97	52mm	TAG1061	
Clio 1. 1.2-1.8 ex 16v	90-07/97	54mm	TAG1062	
Clio 2. 1.1-1.4	03/98-	52mm	TAG1113	
Clio 2. 1.2-1.6 +D	03/98-	58mm	TAG1114	

VW Golf 2 Rear

Please check the distance between the centre of the loop and the bottom of the spring pan on the rear damper and check against the listings to ensure the correct dampers/kits are ordered.

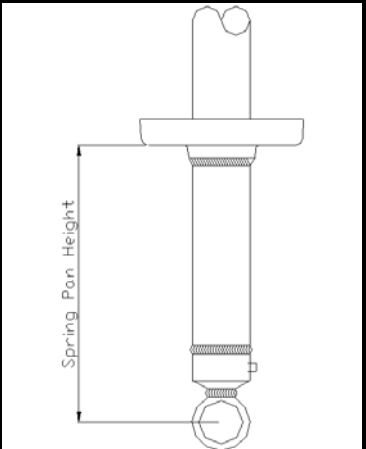
Spring Pan Height	SPAX Part Number	
297mm	G028	
290mm	G044	